

FAR TOOLS®

- FR** *Visseuse à plaque de plâtre (Notice originale)*
- EN** *Plasterboard screw inserter (Original manual translation)*
- DE** *Gipsplattenschrauber (Übersetzung aus dem Original-Anleitung)*
- ES** *Atornillador para placas de yeso (Traducción del manual de instrucciones originale)*
- IT** *Avvitatrice per cartongesso (Traduzione dell'avvertenza originale)*
- PT** *Aparafusadora para gesso (Tradução do livro de instruções original)*
- NL** *Schroevendraaier voor gipsplaat (Vertaling van de originele instructies)*
- EL** *Μηχανή βιδώματος για πλάκες γύψου (Μετάφραση από τις πρωτότυπες οδηγίες)*
- PL** *Wkretarka do płyt kartonowo-gipsowych (Tłumaczenie z oryginalnej instrukcji)*
- FI** *Laastiin ruuvaava porakone (Käännös alkuperäisestä ohjeet)*
- SV** *Skruvdragare för gipsskivor (Översättning från originalinstruktioner)*
- BU** *Skruemaskine til gipsplader (Перевод на оригиналната инструкция)*
- DA** *Gipsplade skruetrækker (Oversættelse fra oprindelige brugsanvisning)*
- RO** *Mașină de înșurubat pentru gips-carton (Traducere din instrucțiunile originale)*
- RU** *Шуруповерт для гипсокартона (Перевод с оригинальной инструкции)*
- TU** *Elektri 'kli` vi`dalama maki`nasi (Orişinal talimatlar çeviri)*
- CS** *Uzavíračka pro sádku (Překlad z originálního návodu)*
- SK** *Uzatvárač na sadru (Preklad z originálneho návodu)*
- HE** *תוירוקמ תוארומה סוגרת) סימלה הגרבמ*
- AR** *(فيلصلأا تاميلعتلا نم قمجرتلا) يئابرهك لغم*
- HU** *Gipszkarton csavarozó (Fordítás az eredeti utasítások)*
- SL** *Vijačnik za mavčne plošče (Prevod iz izvirnih navodil)*
- ET** *Kruvikeeraja kipsmaterjalidele (Tõlge originaal juhiseid)*
- LV** *Apmetuma plākšņu skrūvgriezis (Tulkojumā no instrukcijas oriģinālvalodā)*
- LT** *Gipsinis tvirtinimo aparatas (Vertimas iš originalių instrukcijas)*
- HR** *Odvijač za gips ploče (Prijevod prema originalne upute)*



PM 6C
Professional Machine



© FAR GROUP EUROPE

115009-3-F-2021103

fartools.com



Points de collecte sur www.quefairede mesdechets.fr
Privilégiez la réparation ou le don de votre appareil !

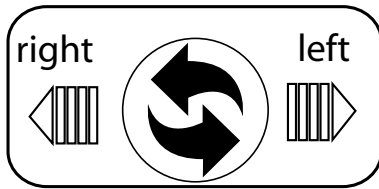

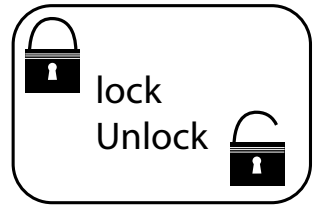

on
off

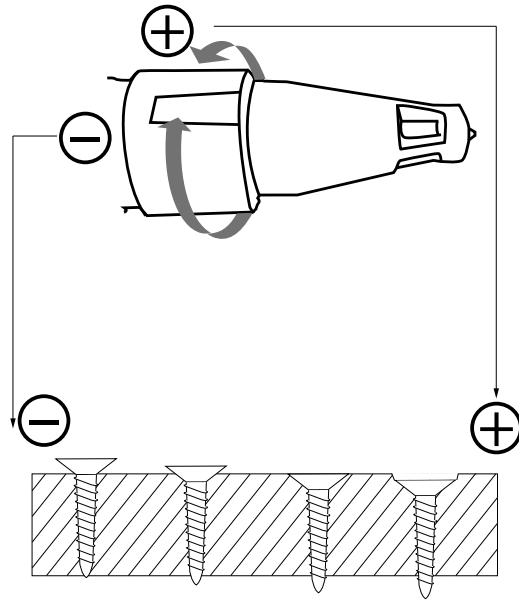





	<p>Tension et fréquence assignée: Nominal frequency and power: Nennspannung und Nennfrequenz : Tensión y frecuencia fijada: Tensione e frequenza assegnata: Tensão e frequência fixa: Aangewezen spanning en frequentie: ΟΝΟΜΑΣΤΙΚΗ ΤΑΣΗ ΚΑΙ ΣΥΧΝΟΤΗΤΑ: Napięcie i częstotliwość przydzielona: Jännite ja määrittäty taajuus: Angiven spänning och frekvens: Anført spænding og frekvens: Tensiune și frecvență de lucru:</p>	<p>Заданное напряжение и частота: Tahsis gerilimi ve frekans: Stanovené napětí a frekvence: Stanovené napätie a frekvencia: Merkespenning og merkefrekvens: الفالطية والذبذبة المبرمجة. Névleges feszültség és frekvencia: Napetost in določena frekvenca: Консумирано напрежение и честота : Määratud pinge ja sagedus Nustatyta įtampa ir dažnis Noteiktais spriegums un frekvence. Napon i nazivna frekvencija:</p>	<p>230 V ~ 50 Hz</p>
---	---	--	----------------------

	<p>Puissance assignée: Nominal power: Nennleistung: Potencia fijada: Potenza assegnata: Potência assinada: Onbelast toerental: ΟΝΟΜΑΣΤΙΚΗ ΙΣΧΥΣ: Prędkość na biegu jałowym: Teho: Angiven effekt: Anført styrke: Putere de lucru:</p>	<p>Заданная мощность: Tahsis edilen güç: Stanovený výkon: Predpísaný výkon: Merkeeffekt: القدرة المبرمجة. Névleges teljesítmény : Določena jakost: Консумирана мощность: Määratud võimsus. Nustatyta galia Noteiktā jauda Nazivna snaga:</p>	<p>520 W</p>
---	---	--	--------------

	<p>Vitesse à vide: No-load speed: Leerlaufdrehzahl: Velocidad vacía: Velocità a vuoto: Velocidade no vácuo: Leerlaufdrehzahl: ΤΑΧΥΤΗΤΑ ΑΔΡΑΝΕΙΑΣ: Prędkość bez bciążenia: Tyhjäkäyntinopeus Tomgångshastighet: Hastighed i ubelastet tilstand: Viteza în gol:</p>	<p>Скорость вращения на холостом ходу: Boşalma hızı: Rychlost naprázdno: Rýchlosť pri chode naprázdno: Tomgangshastighet: السرعة على الفارغ. Üres sebesség: Prosti tek: Скорост на празни обороти: Kiirus tühikäigul Tuščio prietaiso greitis Tukšgaitas ātrums Brzina praznog hoda:</p>	<p>0-4200 min⁻¹</p>
--	---	--	--------------------------------

	<p>Poids : Weight : Gewicht : Peso : Peso : Gewicht : ΒΑΡΟΣ : Masa : Paino : Vikt : Vægt : Greutate :</p>	<p>Вес : Ağırlık : Hmotnosť : Hmotnosť : Vekt: الوزن. Súly : Teža : Тегло : Raskus Svoris Svars Težina</p>	<p>1.60 kg</p>
---	---	--	----------------





 L_{pA}	Niveau de pression acoustique :	Уровень акустического давления. :	85,7 dB (A)
	Acoustic pressure level :	Akustik basınç seviyesi :	
	Schalldruckpegel :	Hladina akustického tlaku :	
	Nivel de presión acústica :	Hladina akustického tlaku :	
	Livello di pressione acustica :	Lydtryknivå:	
	Nível de pressão acústica :	مستوى الضغط المرصومي.	
	Niveau akoestische druk :	A hangnyomás szintje :	
	ΣΤΑΘΜΗ ΗΧΗΤΙΚΗΣ ΠΙΕΣΗΣ:	Nivo akustičnega pritiska:	
	Poziom mocy akustycznej :	Равнище на акустично налягане :	
	Käytä kuulosuojaimia:	Helirõhu nivoo	
Ljudtrycksnivå :	Akustinio spaudimo lygis		
Lydtryk :	Akustiskā spiediena līmenis		
Nivel presiune acustică :	Razina zvučnog tlaka:		

 L_{wA}	Niveau de puissance acoustique :	уровень мощности звука :	96,7 dB (A)
	Acoustic power level :	Akustik basınç seviyesi :	
	Schalleistungspegel :	Hladina zvukového výkonu:	
	Nivel de potencia acústica :	Hladina zvukového výkonu:	
	Livello di potenza acustica:	Lydeffektivnivå:	
	Nível de potência acústica:	مستوى الضغط المرصومي.	
	Niveau akoestisch vermogen :	a hangnyomás szintje :	
	ΕΠΙΠΤΕΔΟ ΙΣΧΥΟΣ ΗΧΟΥ:	Nivo akustične jakosti :	
	Poziom mocy akustycznej :	Равнище на вибрации :	
	Käytä suojalaseja :	Helivõimsuse nivoo	
Ljudstyrkenivå :	Triukšmo lygis		
Lydstyrke :	Akustiskās jaudas līmenis		
Nivel putere acustică :	Razina zvučne snage:		

NIVEAU SONORE D'ÉMISSION :

A VIDE

Pression acoustique LpA poste opérateur
Incertitude

85,7 dB
3

Puissance acoustique LWA
Incertitude

96,7 dB
3

Valeurs déterminées suivant le code d'essai de l'annexe B de la norme EN 61029-1 avec emploi des normes de base ISO 11201 et ISO 3744.

Les niveaux de pression acoustique obtenus in situ dépendent:

- Des niveaux réels de la machine considérées, en prenant en compte les incertitudes déclarées;
- Du local et de l'installation de la machine. Préférez une pièce dont l'acoustique est plus feutrée. Evitez les pièces vides à grande résonance. Placez vous auprès d'une fenêtre le cas échéant.
- Des outils montés, des pièces travaillées, des réglages choisis,...

 a	Niveau de vibration :	Уровень вибрации :	5,993 m / s ²
	Hand/arm vibration level :	Titreşim seviyesi :	
	Vibrationspegel Hand/Arm :	Úroveň vibrací :	
	Nivel de vibración mano/brazo :	Hladina vibrácií :	
	Livello di vibrazione mano/braccio :	Vibrasjonsnivå:	
	Nível de vibração mão/braço :	مستوى الارتجاج.	
	Trillingsniveau hand/arm :	Vibrációsintzint :	
	ΕΠΙΠΤΕΔΟ ΚΡΑΔΑΣΜΩΝ:	Nivo vibracij :	
	Poziom wibracji rżka/ramię :	Равнище :	
	Tärinätaso:	Vibrācijas līmenis.	
Vibrationsnivå hand/arm :	Vibrācijas lygis		
Vibrationsniveau :	Vibratsiooni nivo		
Nivel vibratii :	Razina vibracije:		

VIBRATIONS:

Total des valeurs de vibration (somme vectorielle des trois directions) déterminée selon EN 60745 :

a 5,993 m/s²
Incertitude K 1,5 m/s²

L'amplitude d'oscillation peut être utilisée comme valeur de comparaison d'outils électroportatifs.
Attention : si l'outil électroportatif est utilisé pour d'autres applications, avec d'autres outils de travail, l'amplitude d'oscillation peut être différente.





	<p>Porter des lunettes de sécurité : Wear protective eyewear : Schutzbrille tragen : Llevar puestas gafas protectoras : Portare de gli occhiali di sicurezza : Utilizar óculos de segurança : Draag een veiligheidsbril : ΦΟΡΑΤΕ ΠΡΟΣΤΑΤΕΥΤΙΚΑ ΓΥΑΛΙΑ: Zakładać okulary ochronne : Käytä suojalaseja : Använd skyddsglasögon : Der skal benyttes sikkerhedsbriller : Purtati ochelari de protectie :</p>	<p>Наденьте защитные очки : Güvenlik gözlükleri takın : Používejte bezpečnostní brýle : Noste ochranné okuliare : Bruk vernebriller: حامل نظارات وقائية. Viseljen védőszemüveget : Nositi zaščitna očala : Да се използват защитни очила : Kandke kaitseprille Nešioti apsauginius akinius Valkät aizsargbrilles Nositi zaštitne naočale:</p>	×
---	--	---	---

	<p>Porter un masque anti-poussière : Wear a dust mask : Staubschutzmaske tragen : Llevar puesta una careta de protección contra el polvo : Indossare una mascherina anti-polvere : Utilizar uma máscara anti-poeira : Draag een stofmasker : ΦΟΡΕΣΤΕ ΜΑΣΚΑ ΓΙΑ ΤΗ ΣΚΟΝΗ: Zakładać maskę przeciwpylową Käytä pölysuojust : Bär mask mot damm : Der skal benyttes beskyttelsesmaske mod støv: Purtati mască anti-praf :</p>	<p>Наденьте респиратор : Toza karşı maske takın : Používejte masku proti prachu : Noste ochrannú masku proti prachu : Bruk en støvmaske: لبس قناع حفاض للغباب. Viseljen porvédő maszkot Nositi zaščitno masko proti prahu: Да се използва защитна маска : Kandke tolmumaski. Dëvëti respiratorij Valkät aizsarg masku pret putekļiem Nositi masku za zaštitu od prašine:</p>	×
---	---	--	---

	<p>Porter une protection auditive : Wear hearing protective equipment: Gehörschutz tragen: Llevar puesta una protección auditiva: Portare una protezione uditiva: Utilizar uma protecção auditiva: Draag gehoorbeschermers: ΦΟΡΑΤΕ ΠΡΟΣΤΑΣΙΑ ΑΚΟΗΣ: Zakładać słuchawki ochronne Käytä kuulosuojaimia: Bär hörselskydd: Der skal benyttes høreværn: Purtati căști de protecție auz:</p>	<p>наденьте средства звуковой защиты: İşitsel koruma aleti takın: Používejte ochranu sluchu: Noste ochranné slúchadlá: Bruk hørselsvern: لبس خوذة خوض الخصىج Viseljen fülvédőt Nositi zašito ušes: Да се използва слухови защитни средства: Kandke kõrvakaitset Nešioti apsaugā nuo triukšmo Valkät dzirdes aizsarglīdzekli Nositi štitnike protiv buke:</p>	×
---	--	--	---

	<p>Porter des gants : Use rubber gloves : Schutzhandschuhe tragen : Llevar guantes de protección : Indossare i guanti di protezione : Utilizar luvas de protecção : Draag veiligheidshandschoenen : ΦΟΡΩΝΤΑΣ ΓΑΝΤΙΑ: Używać rękawic ochronnych : Käytä suojakäsineitä : Använd skyddshandskar : Der skal benyttes handsker : Purtati mănuși :</p>	<p>Наденьте перчатки : Eldiven takın : Noste rukavice : Noste rukavice : Bruk hansker: لبس قفازات. Viseljen kesztyű t Nositi rokavice: а се използват предпазни ръкавици : Kandke kindaid Müvëti pirštines Valkät cimdus Nositi zašitne rukavice:</p>	×
---	---	---	---





	<p>Conformité européenne Conforms to EC standards : CE-Konformität : Cumples con las directivas CE : Conforme alle norme CE : Conforme às normas CE : Voldoet aan de EG-normen : ΕΥΡΩΠΑΪΚΗ ΣΥΜΜΟΡΦΩΣΗ Zgodność z normami CE : EU-standardien mukainen : EU-standardien mukainen : Overholder EU standarderne : Conform cu normele europene:</p>	<p>соответствие европейским стандартам: Avrupa uygunluk : evropská shoda : európska dohoda : Europeisk konformitet مطابق للجواصفات الأوروبية. evropska ustreznost : európai megfeleléség : Съответствие с европейските норми : Euroopa Liidu vastavusmärk Europinių normų atitikima Atbilstība Eiropas standartiem Euroopska sukladnost</p>	<p>×</p>
---	---	---	----------

	<p>Lire les instructions avant usage : Read the instructions before use : Vor Einsatz des Geräts Anweisung lesen : Léase las instrucciones antes de usar : Leggere le istruzioni prima dell'uso : Ler as instruções antes da utilização : Lees voor het gebruik de instructies : ΔΙΑΒΑΣΤΕ ΤΙΣ ΟΔΗΓΙΕΣ ΠΡΙΝ ΑΠΟ ΤΗ ΧΡΗΣΗ: Zapoznać się instrukcją przed użyciem : Lue ohjeet ennen käyttöä : Läs anvisningarna före användning : læs instruktionerne før brug Înainte de utilizare, citiți instrucțiunile :</p>	<p>Внимательно прочитайте следующие инструкции : Kullanmadan talimatları okuyunuz : Pozorně si přečtěte následující pokyny : Pred použitím si prečítajte pokyny : Les bruksanvisningen før bruk: اقرأ التعليمات قبل الاستخدام. használat előtt olvassuk el az utasítást : Pred uporabo preberite ustrezna navodila Прочетете указанията за употреба : Enne kasutamist lugege instruksiooni Prieš naudojimą perskaityti instrukciją izlasīt instrukcijas pirms lietošanas Pročitati upute prije uporabe:</p>	<p>×</p>
---	--	---	----------

	<p>Danger : Danger : Gefahr : Peligro : Pericolo : Perigo : Gevaar : ΚΙΝΔΥΝΟΣ: Niebezpieczeństwo : Vaara : Fara : Fare : Pericol :</p>	<p>Опасно : Tehlike : Nebezpečí : Nebezpečnost : Fare: خطر. Veszély : Nevarnost: Опасност : Oht Pavojus Bistamība Opasnost:</p>	<p>×</p>
---	--	---	----------

	<p>Classe d'isolement : 2 Insulation class : 2 Isolierklasse: 2 Aislamiento clase :2 Isolamento classe :2 Isolamento classe :2 Isolatie Klasse : 2 ΚΑΤΗΓΟΡΙΑ ΜΟΝΩΣΗΣ: 2 Izolacija Klasy :2 Eristysluokka :2 Isolering Klass :2 Isoleringsklasse 2 Clasă izolație :2</p>	<p>Класс изоляции 2 : Yalıtım derecesi :2 Třída izolace :2 Izolačný systém 2 Isolasjonsklasse: 2 فئۃ العزل 2. Szigetelési osztály :2 Razred izolacije :2 Инструмент Клас :2 Isolatsiooniklass 2 Izolācijas rūšis 2 Izolācijas klase 2 Izolacija klasa: 2</p>	<p>×</p>
---	---	--	----------

<p>IP 20</p>		<p>×</p>
--------------	--	----------





	<p>Soumis à recyclage Subjected to recycling Sujeto a reciclaje Sottoposti a riciclaggio Sujeitos à reciclagem Não deite no lixo : Niet wegwerpen : ΥΠΟΚΕΙΤΑΙ ΣΕ ΑΝΑΚΥΚΛΩΣΗ Nie wyrzucac : Älä heitä pois luontoon : Batteriet får inte kastas : Bortkast det ikke: Nu le auncati :</p>	<p>Подлежит переработке Atmayıniz : Nevyhazižte je do bežného odpadu : Neodhadzovat : Gjenvinningspliktig فلا ترحدها لهذا في القمامة. ne mečíte! Ne odvržite ga/jih vstran : Taaskasutusse kuuluv Ärge visake seda minema : Nemétykíte : Nemest : Podvrgnuto recikliranju</p>	×
---	---	---	---

Recyclage des déchets :

Les outils, accessoires et leur emballages doivent suivre une voie de recyclage adaptée. Conformément aux directives Européenne 2012/19/UE et 2006/66/CE, les composants d'un produit doivent être séparés, collectés, recyclés ou éliminés en conformité avec les réglementations environnementales en vigueur. Les appareils, batteries, piles, huiles, emballages devront être déposés dans les systèmes d'élimination des déchets spéciaux tels que déchetteries. Renseignez-vous auprès de votre commune pour connaître l'organisme le plus proche à même de retraiter ou de collecter ces déchets.

	<p>Recyclable, soumis au tri sélectif Recyclable, subject to recycling Recyclingfähige, unterliegen Recycling Reciclables, sujetos a reciclaje Riciclabili, soggetti a riciclaggio Recicláveis, sujeito à reciclagem Recycleerbare, onderworpen aan recycling ΑΝΑΚΥΚΛΩΣΙΜΟ, ΥΠΟΚΕΙΤΑΙ ΣΕ ΕΠΙΛΕΚΤΙΚΗ ΔΙΑΛΟΓΗ Opakowanie nadaje się do recyklingu podlegają recyklingu Kierrätettävien pakkausten kohteena kierrätys Återvinningsbara förpackningar omfattas återvinning Рециклираци се опаковки подлежат на рециклиране Genanvendelig underlagt genbrug</p>	<p>Reciclabile sub rezerva reciclare Повторно упаковка подлежит вторичной переработке Gerí dönüŝüm Geri dönüŝürülebilir ambalaj konusu Recyklovateľné podléhajúci recyklácii Recyklovateľné podliehajúce recyklácii Resirkulerbar, med forbehold om selektiv sortering ريودتلا خا مال عيش ريويدتلا خا مال لباؤلا فحول يتلا و توب يتلا Újrahasznosítható csomagolás alá újrahasznosítás Reciklirati predmet recikliranje Pakendite suhtes ringlussevõtu Pärstrådājams iepakojums otrreizējai pārstrādei Perdirbamų taikomos perdirbimo Može se reciklirati, podložno selektivnom sortiranju</p>	×
---	--	--	---





PM 6C

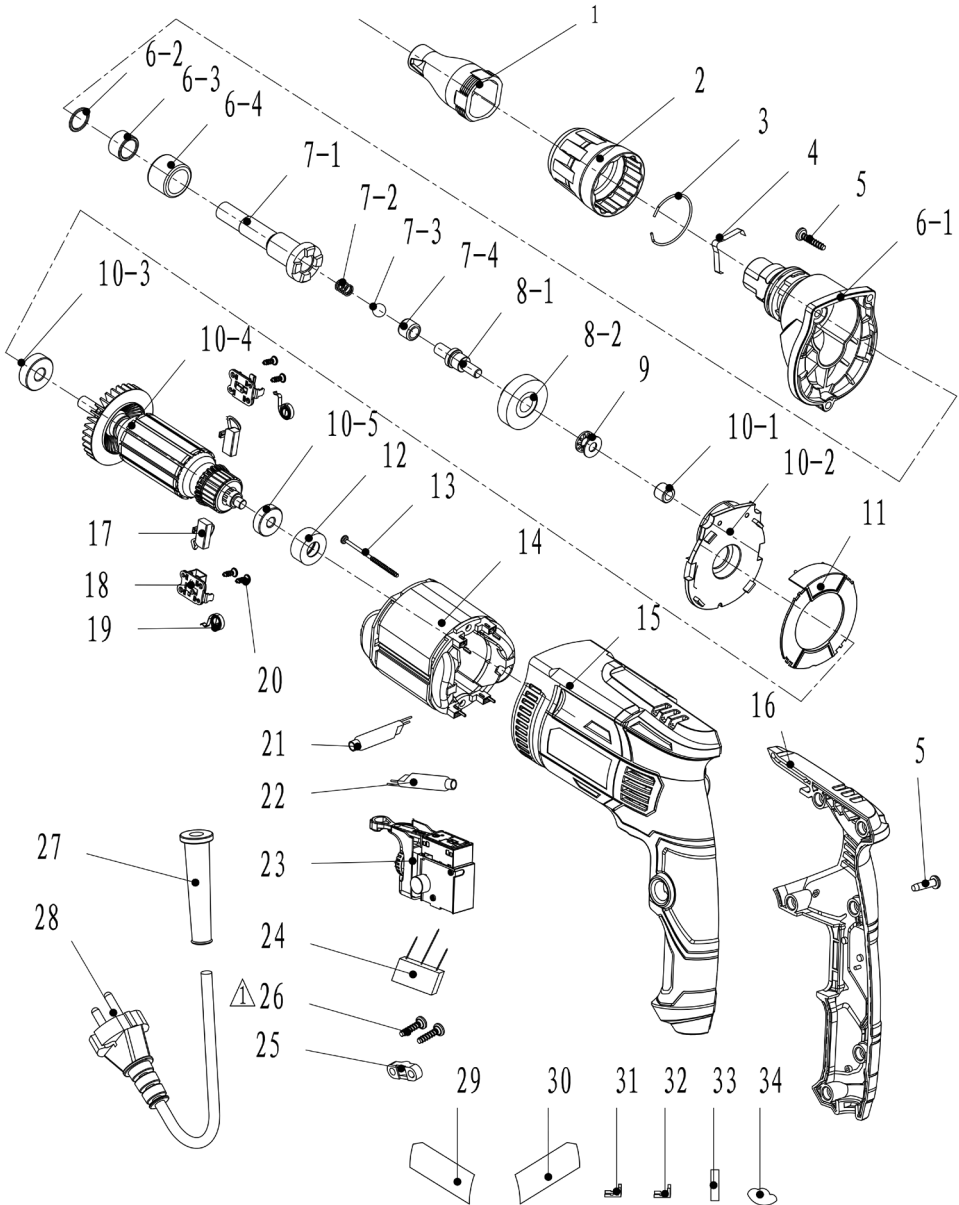

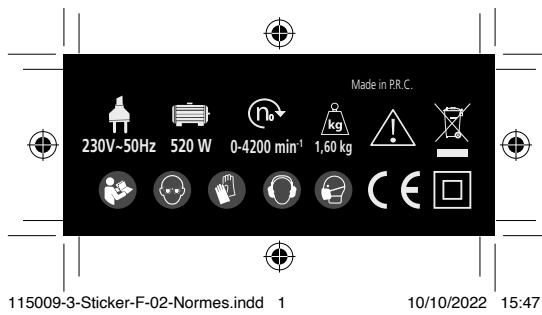

DECLARATION DE CONFORMITE
VERKLARING VAN OVEREENSTEMMING
DECLARACION DE CONFORMIDAD
DICHIARAZIONE DI CONFORMITA
KONFORMITÄSERKLÄRUNG
DECLARATION CONFORMITY
DECLARAÇÃO DE CONFORMIDADE
DEKLARACJA ZGODNOSCI Z NORMAMI
OM ÖVERENSSTÄMMELSE
VAATIMUSTENMUKAISUUSVAKUUTUS
OVERENSSTEMMELSESERKLÆRING
ΔΗΛΩΣΗ ΣΥΜΜΟΡΦΩΣΗΣ

DECLARAȚIE DE CONFORMITATE
VYHLÁSENIE ZHODY
Декларация соответствия
SAMSVARERKLÆRING
Uygunluk beyanı
التصريح بالامتثال
PROHLÁSENÍ SHODY
EGYZŐSÉGI NYILATKOZAT
Декларация за съответствие с нормите
IZJAVA O SKLADNOSTI
DEKLARACIJA
ATITIKTES DEKLARACIJA
KINNITUS
IZJAVA O SUKLADNOSTI

Le soussigné,
Ondergetekende,
Der Unterzeichner,
O abaixo assinado,
Undertecknad,
Долуподписаният
Undertegnede
Subseminatul,
Я, нижеподписавшийся,
Imzalayan,
Niže podepsany,
Toliau pasirašęs

Déclare par la présente que,
Verklaart hiermede dat,
Erklårt hiermit daß,
Declaro pela presente que,
Förklarar härmed att
Заявява с настоящото
erklærer hermed, at
Declar prin prezenta că,
настоящим подтверждаю, что
Mevcut belgeye beyan ediliyorum ki,
tímto prohlašuje, že,
Pareiskia, kad,

Personne autorisée à constituer
le dossier technique :
Christophe HUREL



FAR GROUP EUROPE
192, Avenue Yves Farge
37700 St. Pierre-des-Corps
FRANCE

El suscrito,
Il sottoscritto,
The undersigned,
Ninej podpišany
Allekirjoittanut,
Ο ΚΑΤΩΘΙ ΥΠΟΓΡΑΜΜΕΝΟΣ,
Nižšie podpišany
Undertegnede,
الذوق اع انزاء
Alulírótt,
Podpisani,
Apakša parakstijies
alakirjutanu
Dolje potpisani,

Declaro por la presente, que,
Dichiaro che,
Declaras that,
Oświadczam niniejszym, że
Ilmoittaan täten että,
ΔΙΑ ΤΟΥ ΠΑΡΟΝΤΟΣ ΔΗΛΩΝΕΙ ΟΤΙ,
týmto vyhlášu, že
Erklærer herved at,
يصدوح اسحقنا ادا على ذلك
kijeleittem, hogy a készülék Izjavlja da,
Pareiskia, kad,
Ar šo apliecinā, ka,
Kinnitab, et
Izjavljuje u ovom dokumentu da je

Visseuse à placoplâtre / Plasterboard screw inserter / Gipsplattenschrauber / Atornillador para placas de yeso / Avvitatrice per cartongesso / Aparafusadora para gesso / Schroevendraaier voor gipsplaat / Μηχανή βιδωματος για πλάκες γύψου / Wkretarka do płyt kartonowo-gipsowych / Laastin ruuvaava porakone / Skruvdragare för gipskvivor / Skruemaskine til gipsplader / Машина за завинтане с гипсова фурнирна облицовка / Mašinà de însurubât pentru gips-carton / Шурупверт для гипсокартона / Elektriķi vidalama makinasī / Uzaviračka pro sadru / Uzatvárač na sadru / סימלה הרבר / یی ایرک لغم / Gipskarton savarozó / Vijačnik za mavčne plošče / Kruvikeeraja kipsmaterjalidele / Apmetuma plākšņu skrūvgriezis / Gipsinis tvirtinimo aparatas

code

FARTOOLS / 115009 / PM 6C / R8502A

Est conforme et satisfait aux directives et normes CE,
In overeenstemming is met en Voldoet aan EG richtlijnen,
Den folgenden EU-Bestimmungen entspricht,
Respeita e está em conformidade com as normas CE,
Överensstämmer med och uppfyller EG-standarder,
Съответства и отговаря европейските норми
Er i overensstemmelse med og overholder EU standarderne
Este conform și satisface normele CE
полностью соответствует и удовлетворяет
требованиям стандартов ЕС
CE şartlara uygundur,
odpowiada normám ES,
Atitinka ir atitinka EB direktyvas ir standartus,

Cumple con la directivas de la CE,
E conforme alle direttive CEE,
Complies with the EEC directives and standards,
Odpowiada normom UE,
Täyttää EU-vaatimukset,
ΣΥΜΜΟΡΦΩΝΕΤΑΙ ΚΑΙ ΙΚΑΝΟΠΟΙΕΙ ΤΙΣ ΟΔΗΓΙΕΣ ΚΑΙ ΤΑ ΠΡΟΤΥΠΑ CE,
zodpovedá normám ES,
Samsvarer med og tilfredsstillter CE-direktiver og standarder,
بأن الیواء یطابق و یلیدی مع ایییر مع جموع الدول الأوردوبیة
kielegíti a CE szabványok előírásait.
Je v skladu z in izpolnjuje norme Evropske skupnosti.
Atbilst un atbilst EK direktivas un standartus.
Vastab ja vastab EU direktīviudeļe ja standartiteļe,
Sukladan i ispunjava direktive i standarde CE,

2006/42/EC 2014/30/EU 2011/65/EU&2015/863/EU

EN IEC 55014-1:2021
EN IEC 55014-2:2021
EN 55014-1:2017/A11:2020
EN 55014-2:2015
EN IEC 61000-3-2:2019
EN IEC 61000-3-2:2019/A1:2021
EN 61000-3-3:2013/A1:2019
EN 62841-1:2015
EN 62841-2-2:2014
EK9-BE-88(V2):2020
AfPS GS2019:01PAK

Christophe HUREL,
Président Directeur Général
15/02/2022
Fait à St. Pierre-des-Corps

GARANTIE - WARRANTY



FR. GARANTIE

Cet outil est garanti contractuellement contre tout vice de construction et de matière, à compter de la date de vente à l'utilisateur et sur simple présentation du ticket de caisse. La garantie consiste à remplacer les parties défectueuses. Cette garantie n'est pas applicable en cas d'exploitation non conforme aux normes de l'appareil, ni en cas de dommages causés par des interventions non autorisées ou par négligence de la part de l'acheteur. La garantie ne s'applique pas sur les dommages causés par une défaillance de l'outil.

DE. GARANTIE

Die Garantiezeit für dieses Gerät in bezug auf Konstruktions- und Materialfehler beträgt lt. Vertrag bei Vorlage des Kassensbons. Die Garantieleistung besteht im Ersatz schadhafter Teile. Die Garantie erlischt bei einem Einsatz des Geräts, der nicht normentsprechend ist, bei Schäden, die auf unsachgemäße Eingriffe zurückzuführen sind bzw. bei Nachlässigkeiten seitens des Käufers. Die Garantie erstreckt sich nicht auf Schäden, die auf Fehlfunktionen des Geräts zurückzuführen sind.

IT. GARANZIA

Quest' attrezzo è garantito per contratto contro qualsiasi difetto di costruzione e di materia, a partire dalla data di vendita all'utente e su semplice presentazione dello scontrino. La garanzia consiste nel sostituire le parti difettose. Questa garanzia non è applicabile in caso di sfruttamento non conforme alle norme dell'apparecchio, né in caso di danni causati da interventi non autorizzati o da negligenza da parte dell'acquirente. La garanzia non si applica ai danni causati da un'avaria dell'attrezzo.

EN. GARANTIE

This tool is guaranteed, in writing, against any defect in manufacture or parts from the date of sale, upon simple presentation of the sales slip. The guarantee is limited to the replacement of faulty parts. This guarantee is not applicable in the event of usage which is not conform with the intended usage of the apparatus, nor in the event of damage caused by unauthorised servicing or negligence on behalf of the purchaser. This guarantee does not apply to any damage caused by the failure of this tool.

ES. GARANTIA

Esta herramienta se garantiza contractualmente contra todo defecto de construcción y materia, a partir de la fecha de venta a l' usuario y sobre simple presentación del recibo de caja. La garantía consiste en sustituir a las partes defectuosas. Esta garantía no es aplicable en caso de explotación no conforme a las normas del aparato, ni en caso de danos causados por intervenciones no autorizadas o por negligencia por parte del comprador. La garantía no se aplica sobre los danos causados por un fallo del herramienta.

NL. GARANTIE

Dit gereedschap heeft een garantie tegen constructiefouten en materiaaldefecten, die geldig is vanaf de aankoopdatum door de gebruiker, op vertoning van de kassabon. De garantie betreft de vervanging van de defecte onderdelen. Deze garantie is niet van toepassing indien het apparaat niet volgens de normen gebruikt is, noch in geval van schade veroorzaakt door onbehoorlijk gebruik of nalatigheid van de koper. De garantie is niet van toepassing op schade voortvloeiend uit een defect van het gereedschap.

PT. GARANTIA

Esta ferramenta tem uma garantia contratual contra qualquer defeito de construção e de material, a partir da data de venda ao utilizador e sobre simples apresentação do talão da caixa. A garantia consiste em substituir as partes defeituosas. Esta garantia não é aplicável no caso de exploração não conforme as normas do aparelho, nem em caso de danos causados pelas intervenções não autorizadas ou por negligência da parte do comprador. A garantia não se aplica para os danos causados por uma falha da ferramenta.

EL. ΕΓΓΥΗΣΗ

ΑΥΤΟ ΤΟ ΕΡΓΑΛΕΙΟ ΕΙΝΑΙ ΣΥΜΒΑΤΙΚΑ ΕΓΓΥΗΜΕΝΟ ΓΙΑ ΟΠΟΙΟΔΗΠΟΤΕ ΚΑΤΑΣΚΕΥΑΣΤΙΚΟ ΚΑΙ ΥΛΙΚΟ ΕΛΑΤΤΩΜΑ, ΑΠΟ ΤΗΝ ΗΜΕΡΟΜΗΝΙΑ ΠΩΛΗΣΗΣ ΣΤΟΝ ΧΡΗΣΤΗ ΚΑΙ ΜΕ ΤΗΝ ΕΠΙΔΕΙΞΗ ΤΗΣ ΑΠΟΔΕΙΞΗΣ ΠΩΛΗΣΗΣ. Η ΕΓΓΥΗΣΗ ΣΥΝΙΣΤΑΤΑΙ ΣΤΗΝ ΑΝΤΙΚΑΤΑΣΤΑΣΗ ΤΩΝ ΕΛΑΤΤΩΜΑΤΙΚΩΝ ΕΞΑΡΤΗΜΑΤΩΝ. ΑΥΤΗ Η ΕΓΓΥΗΣΗ ΔΕΝ ΙΣΧΥΕΙ ΣΕ ΠΕΡΙΠΤΩΣΗ ΛΕΙΤΟΥΡΓΙΑΣ ΠΟΥ ΔΕΝ ΣΥΜΜΟΡΦΩΝΕΤΑΙ ΜΕ ΤΑ ΠΡΟΤΥΠΑ ΤΗΣ ΣΥΣΚΕΥΗΣ, ΟΥΤΕ ΣΕ ΠΕΡΙΠΤΩΣΗ ΖΗΜΙΑΣ ΠΟΥ ΠΡΟΚΑΛΕΙΤΑΙ ΑΠΟ ΜΗ ΕΥΣΥΙΟΔΟΤΗΜΕΝΕΣ ΕΠΕΜΒΑΣΕΙΣ Ή ΑΜΕΛΕΙΑ ΕΚ ΜΕΡΟΥΣ ΤΟΥ ΑΓΟΡΑΣΤΗ. Η ΕΓΓΥΗΣΗ ΔΕΝ ΙΣΧΥΕΙ ΓΙΑ ΖΗΜΙΕΣ ΠΟΥ ΠΡΟΚΑΛΟΥΝΤΑΙ ΑΠΟ ΑΣΤΟΧΙΑ ΕΡΓΑΛΕΙΟΥ.

PL. GWARANCJA

Narz dzie jest objęte gwarancją w wszelkie wady konstrukcyjne i materiałowe, licząc od daty

sprzedaży u użytkownikowi i po okazaniu paragonu kasowego. Gwarancja obejmuje wymianę części wyprakowanych. Gwarancja nie znajduje zastosowania w przypadku użytkowania niezgodnego z normami urzędzenia, ani w przypadku szkód spowodowanych działaniami niedozwolonymi lub zaniedbaniami ze strony nabywcy. Gwarancja nie obejmuje szkód powstałych z powodu upadku urzędzenia.

SV. GARANTI

Detta verktyg har en avtalsenlig garanti mot konstruktions och materialfel, från och med tidpunkten för användarens inköp och genom uppvisning av kassakvittot. Garantin består i att ersätta de bristfälliga delarna. Denna garanti gäller inte om användningen inte motsvarar apparatens ståndarder, inte heller vid skador som orsakas av ej tillåtna ingrepp eller på grund av koparens vårdslöshet. Garantin gäller inte förskador som orsakats av att verktyget fungerat bristfälligt.

FI. TAKUU

Tämän laitteen takuu on voimassa sopimuksenmukaisesti kattaa kaikki rakenne- ja materiaaliiviat lukien ostopaivasta, kassakuitilla vastaan. Takuu sisältää viallisten osien korvaamisen. Takuu ei korvaa ohjeiden vastaista käyttöä eikä vialtuuttamattomien henkilöiden kasittelystä tai ostajan huolimattomuudesta aiheutuneita vahinkoja. Takuu ei vastaa myöskään toimintahairiosta aiheutuneita vahinkoja.

BU. Гаранция

Този инструмент е под договорна гаранция срещу всякакъв дефект в изработката и използваните материали, считано от датата на продажба на потребителя и само срещу представяне на касовата бележка. Гаранционното обслужване се състои в замяна на дефектните части. Настоящата гаранция не е валидна когато апаратът се използва по начин, несъответстващ на стандарта за работа с него, както и в случай на щети, нанесени от неотторизирани лица, или вследствие на проявена небрежност от страна потребителя.

Гаранцията не покрива щети, произтекли вследствие на техническа неизправност на апарата.

DA. GARANTI

Dette værktøj er dækket af en garantikontrakt for konstruktions- og materialefejl, som gælder fra købsdatoen ved visning af kassabon. Garantien består i at udskifte de defekte dele. Garantien dækker ikke fejl opstået som følge af anvendelse, som ikke overholder standarderne for apparatet, eller

SERVICE APRÈS VENTE - AFTER SALE SERVICE

FARGROUP EUROPE - 192, Avenue Yves Farge - 37700 St. Pierre-des-Corps - FRANCE

fargroup@fargroup.net

GARANTIE - WARRANTY



skader opstået ved ikke autoriserede indgreb eller sløsethed fra brugerens side. Garantien dækker ikke skader opstået, fordi værktøjet har svigtet.

RO. GARANTIE

Acest aparat este garantat din punct de vedere contractual împotriva tuturor viciilor de construcție și de material, începând de la data vânzării lui către utilizator și la simpla prezentare a bonului de casă. Garanția constă în înlocuirea componentelor defecte. Această garanție nu se aplică în cazul exploataării în alt mod decât cel recomandat de normele aparatului și nici în caz de stricăciuni provocate de intervenții neautorizate sau prin neglijența cumpărătorului. Garanția nu se aplică asupra pagbelor cauzate de o defectare a aparatului.

RU. ГАРАНТИЯ

Данное изделие обладает имеющей силу контракта гарантией, покрывающей все возможные дефекты изготовления и материала. Гарантия вступает в силу с даты продажи изделия пользователю, для этого достаточно сохранить и предъявить полученный в кассе чек. Гарантия обязывает изготовителя заменить дефектные части изделия. В случае не соответствующего нормам использования изделия, несанкционированного демонтажа или ремонта или небрежного обращения действие гарантии прекращается. Гарантия не покрывает ущерба, возникшего в результате сбоя в работе изделия.

TU. GARANTII

Bu, arac, satis tarihinden itibaren, kullanicihin sadece vezne itibindisi sunmasiya tum uretim ve malzeme hatasina karsi garantilidir. Garanti eksik olan kisimlari degistirmek icindir. Bu garanti aracin sartlarina uygun olmayan isleme durumunda, izin verilmeyen kullanimlardan kaynaklanan hasarlarda, veya alicinin isteği durumunda uygulanmaz. Garanti malzemenin bir eksikliginden meydana gelen bir zararda uygulanmaz.

CS. ZÁRUKA

Pro tento nástroj platí smluvní záruka na všechny výrobny a materiálové vady od data prodeje uživateli a na základe predložení pokladniho bloku. Záruka spočíva ve výmene vadných častí. Táto záruka neplatí v prípade použiti prístroje, ktoré

neodpovídá normám, ani v případě škod způsobených nepovolenými zásahy nebo nedbalostí ze strany kupujícího. Záruka se nevztahuje na škody způsobené závadou nástroje.

SK. ZÁRUKA

Pre tento nástroj platí zmluvná záruka na všetky výrobné a materiálové chyby od dátumu predaja uživateli a na základe predloženia pokladničného bloku. Záruka spočíva vo výmene chybných častí. Táto záruka neplatí v prípade použitia prístroja, ktoré nezodpovedá normám, ani v prípade škod spôsobených nepovolenými zásahmi alebo nedbalosťou zo strany kupujúceho. Záruka sa nevztahuje na škody spôsobené poruchou nástroja

AR. الضمان

على مجرد تقديم بطاقة الشراء يتدفع من تاريخ البيع الى المستهلك وينبأ عن تاريخ الضمان عوفى الجوانب. إن هذه الأعد مضمونة كعقودى عن أي الحراز، ولا فى حالة تعرضه للإتلافات حالة الإستهلاك غير المطابق لمعايير لا يكون هذا الضمان قابلاً للتطبيق فى حالة الضمان فى سبببدال الأجزاء أو عطلة لا ينطبق الضمان على الخيدرات ع من مرسنة أو فى حالة الإعمال من قبل المشتري زاتية عن عمليات تدخلى غير

HU. GARANCIA

Erre a szerszámra szerződéses garanciát vállalunk bármilyen bvtartási és anyaghiba felmerülése esetére a fogvaszto reszere törtent eladás napjától számítva, a pénztári blokk egyszerű felmuntatása elleneben. A garancia a hibás alkatrészek cseréjére terjed ki. Ez a garancia nem érvényes, ha a készleket nem rendeltetésszerűen használtak, sem illetéktelen beavatkozások vagy a vásárló hanyagsága okozta karok esetén. A garancia nem fedezi azokat a karokat, melyeket a szerszám hibás működése okozott.

SL. GARANCIA

To orodje je z garancijsko pogodbo zašciteno proti vsem napakam v izdelavi in v sestavnem materialu od datuma prodaje naprej in ta velja ob predložitvi blagajniškega računa. Garancija velja za zamenjavo delov z napako. Ta garancija ne velja za uporabo orodja, ki ni v skladu z normami, predpisanimi za omenjeno orodje in za primere okvar, ki nastanejo zaradi nedovoljenih posegov na orodju ali zaradi malomarnega rokovanja kupca. Garancija ne velja za škodo, ki jo lahko povzroci okvara orodja.

ET. GARANTII

See tööriist kuulub lepingu järgi garantiiremonti arvestades alates müumise päevast ja kassatseki alusel kasutatule koigi konstruktsiooni- ja materjalivigade puhul. Garantii

seisneb defektsete osade väljavahetamisega. See garantii ei kehti aparaadi normide ebatavalise eiramise puhul ega ostja poolt keelatud viisil kasutamistest või hooletusetahtmisest tulenevate kahjude korral. Garantii ei kehti seadme defektidest põhjustatud kahjude puhul

LV. GARANTĪJA

Sis prietaisās yra uztikrinamas kaip itin geros kokybės, nuo jo pardavimo datos iki jo panaudojimo, ir jam yra suteikiamas garantinis talonas. Garantijos metu galima pakeisti atsiradusius trumplataikius gedimus. Si garantija netaikoma esant netinkamam naudojimui ar nesilaikant reikiamų šio aparato vartojimo instrukcijų, tai pat paciam parkėjui ji sugadinus. Garantija taip pat netaikoma, prietaisą naudojant ne pagal paskirtį ir/ai apgadinus

LT. GARANTUJA

Sim darbarikam, ir liguma noteikta garantija visiem defektiem, kas saistās ar konstrukciju un materialu, sākot ar pardosanas datumu, kad masinu pardod lietotajam un vienkarši uzradot kases ceku. Garantija iekļauj bojoto dalu nomainu. Si garantija nav derīga, ja aparāts nav lietots saskaņā ar drošības noteikumiem, ne gādijumos ja bojājumi radusies nesankcionētās ietaukšanas gādijuma vai arī pircēja nolaidības dēļ. Garantija nav derīga, ja bojājumi radusies darbarika defekta dēļ

HR. JAMSTVO

Ovaj alat ima ugovorno jamstvo u slučaju bilo kakvih nedostataka u konstrukciji i materijalu, od datuma prodaje korisniku uz jednostavno predocenje racuna. Jamstvo se sastoji u zamjeni neispravnih dijelova. Ovo se jamstvo ne primjenjuje u slučaju uporabe i eksploatacije koja nije sukladna standardima uređaja, niti u slučaju stete uzrokovane neovlaštenim intervencijama ili nemarkom kupca. Jamstvo se ne primjenjuje na štetu uzrokovanu nekim nedostatkom alata.

SERVICE APRÈS VENTE - AFTER SALE SERVICE

FARGROUP EUROPE - 192, Avenue Yves Farge - 37700 St. Pierre-des-Corps - FRANCE

fargroup@fargroup.net



FAR GROUP EUROPE

Une société du groupe **SIGMA**

192, Avenue Yves Farge
37700 St. Pierre-des-Corps
FRANCE

fartools.com

