

FAR TOOLS®



AG 50
Professional Machine

FR	<i>Aiguiseur universel (Notice originale)</i>
EN	<i>Universal sharpener (Original manual translation)</i>
DE	<i>Universalschleifer (Übersetzung aus dem Original-Anleitung)</i>
ES	<i>Afilador universal (Traducción del manual de instrucciones originale)</i>
IT	<i>Affilatore universale (Traduzione dell'avvertenza originale)</i>
PT	<i>Afiador universal (Tradução do livro de instruções original)</i>
NL	<i>Universeel slijptoeestel (Vertaling van de originele instructies)</i>
EL	<i>Μηχανή ακονίσματος γενικής χρήσης (Μετάφραση από τις πρωτότυπες οδηγίες)</i>
PL	<i>Ostrzałka uniwersalna (Tłumaczenie z oryginalnej instrukcji)</i>
FI	<i>Veitsenteroitin (Käännös alkuperäisestä ohjeet)</i>
SV	<i>Univeralsvässare (Översättning från originalinstruktioner)</i>
BU	<i>Универсален шмиргел (Превод на оригиналната инструкция)</i>
DA	<i>Universal knivskærper (Oversættelse fra oprindelige brugsanvisning)</i>
RO	<i>Polizor universal (Traducere din instrucțiunile originale)</i>
RU	<i>Универсальная заточка (Перевод с оригинальной инструкции)</i>
TU	<i>Üniversal bileyici (Orijinal talimatlar çeviri)</i>
CS	<i>Univerzální brusič (Překlad z originálního návodu)</i>
SK	<i>Univerzálny brusič (Preklad z originálneho návodu)</i>
HE	<i>(חיתוך אריח חשמלי) משחת כלל-שימושית</i>
AR	<i>(قوي لحرأال تااعيل عتلل نمل قمل جرتلل) .خزار غالل ماع ذل حشرم</i>
HU	<i>Univerzális élesító (Fordítás az eredeti utasítások)</i>
SL	<i>Univerzalni brusilnik (Prevod iz izvornih navodil)</i>
ET	<i>Universaalne teritaja (Tõlge originaal juhiseid)</i>
LV	<i>Universalus galāstošanas (Tulkojumā no instrukcijas oriģinālvalodā)</i>
LT	<i>Univeršialus asinātājs (Vertimas iš originalių instrukcijas)</i>
HR	<i>Univerzalno oštrenje (Prijevod prema originalne upute)</i>



© FAR GROUP EUROPE

110162-Manual-F-20230426



fartools.com



1 min





Description et repérage des organes de la machine
Description and location of machine parts

A



Contenu du carton
Contents of box

C



Points de collecte sur www.guidefroidemarchets.fr
Privilégiez la réparation ou le don de votre appareil !





Fonctionnalité de la machine
Functions of the machine

E

01

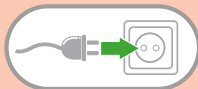

02



Meulage gros grain
Hard sharpening



Finition grain fin
soft sharpening

03

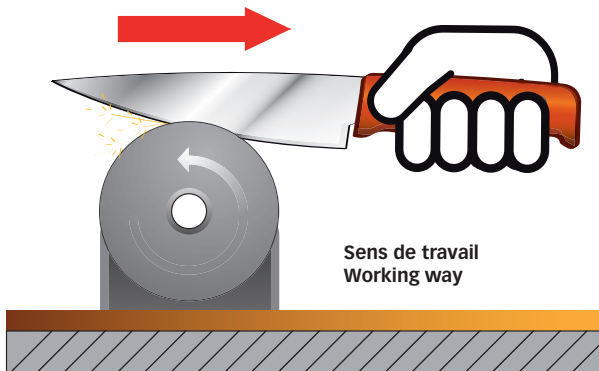

Sens de travail
Working way



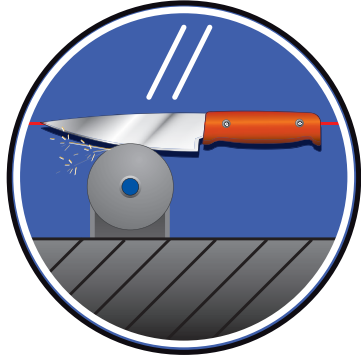



	<p>Tension et fréquence assignée: Nominal frequency and power: Nennspannung und Nennfrequenz : Tensión y frecuencia fijada: Tensione e frequenza assegnata: Tensão e frequência fixa: Aangewezen spanning en frequentie: ΟΝΟΜΑΣΤΙΚΗ ΤΑΣΗ ΚΑΙ ΣΥΧΝΟΤΗΤΑ: Napięcie i częstotliwość przydzielona: Jännite ja määrätty taajuus: Angiven spänning och frekvens: Anført spænding og frekvens: Tensiune și frecvență de lucru:</p>	<p>Заданное напряжение и частота: Tahsis gerilimi ve frekansi: Stanovené napätí a frekvence: Stanovené napätie a frekvencia: Merkespenning og merkefrekvens: الغاططية والذنبذبة الجبرمجة: Névleges feszültség és frekvencia: Napetost in določena frekvenca: Консумирано напрежение и честота : Määratud pinge ja sagedus Nustatyta jtampa ir dažnis Noteiktais spriegums un frekvence. Napon i nazivna frekvencija:</p>	230 V ~ 50 Hz
--	---	--	---------------

	<p>Puissance assignée: Nominal power: Nennleistung: Potencia fijada: Potenza assegnata: Potência assinada: Onbelast toerental: ΟΝΟΜΑΣΤΙΚΗ ΙΣΧΥΣ: Prędkość na biegu jałowym: Teho: Angiven effekt: Anført styrke: Putere de lucru:</p>	<p>Заданная мощность: Tahsis edilen güç: Stanovený príkon: Predpísaný výkon: Merkeeffekt: القدرة الجبرمجة: Névleges teljesítmény : Določena jakost: Консумирана мощност: Määratud võimsus. Nustatyta galia Noteiktā jauda Nazivna snaga:</p>	20 W
--	---	--	------

		ø 50 x ø 6 x 16 mm
--	--	--------------------

	<p>Vitesse à vide: No-load speed: Leerlaufdrehzahl: Velocidad vacía: Velocità a vuoto: Velocidade no vácuo: Leerlaufdrehzahl: ΤΑΧΥΤΗΤΑ ΑΔΡΑΝΕΙΑΣ: Prędkość bez bciążenia: Tyhjäkäyntinopeus Tomgångshastighet: Hastighed i ubelastet tilstand: Viteza în gol:</p>	<p>Скорость вращения на холостом ходу: Boşalma hızı: Rychlost naprázdno: Rýchlosť pri chode naprázdno: Tomgangshastighet: السدرعة على الفسارغ: Üres sebesség: Prosti tek: Скорост на празни обороти: Kiirus tühikäigul Tuščio prietaiso greitis Tukšgaitas ātrums Brzina praznog hoda:</p>	3700.min ⁻¹
--	---	--	------------------------

	<p>Classe d'isolement : 2 Insulation class : 2 Isolierklasse: 2 Aislamiento clase :2 Isolamento classe :2 Isolamento classe :2 Isolatie Klasse : 2 ΚΑΤΗΓΟΡΙΑ ΜΟΝΩΣΗΣ: 2 Izolacja Klazy :2 Eristysluokka :2 Isolering Klass :2 Isoleringsklasse 2 Clasă izolatie :2</p>	<p>Класс изоляции 2 : Yalitim derecesi :2 Třída izolace :2 Izolačný systém 2 Isolasjonsklasse: 2 فصية الازل 2: Szigetelési osztály :2 Razred izolacije :2 Инструмент Класс :2 Isolatsiooniklass 2 Izolācijas rūšis 2 Izolācijas klase 2 Izolacija klasa: 2</p>	X
--	--	--	---





	<p>Porter des lunettes de sécurité : Wear protective eyewear : Schutzbrille tragen : Llevar puestas gafas protectoras : Portare de gli occhiali di sicurezza : Utilizar óculos de segurança : Draag een veiligheidsbril : ΦΟΡΑΤΕ ΠΡΟΣΤΑΤΕΥΤΙΚΑ ΓΥΑΛΙΑ: Zakładać okulary ochronne : Käytä suojalaseja : Använd skyddsglasögon : Der skal benyttes sikkerhedsbriller : Purtati ochelari de protecție :</p>	<p>Наденьте защитные очки : Güvenlik gözlükleri takın : Používejte bezpečnostní brýle : Noste ochranné okuliare : Bruk vernebriller: حمله نظارات وقائية. Viseljen védőszemüveget : Nositi zaščitna očala : Да се използват защитни очила : Kandke kaitseprille Nešioti apsauginius akinius Valkāt aizsargbrilles Nositi zaštitne naočale:</p>	×
---	--	---	---

	<p>Porter un masque anti-poussière : Wear a dust mask : Staubschutzmaske tragen : Llevar puesta una careta de protección contra el polvo : Indossare una mascherina anti-polvere : Utilizar uma máscara anti-poeira : Draag een stofmasker : ΦΟΡΕΣΤΕ ΜΑΣΚΑ ΓΙΑ ΤΗ ΣΚΟΝΗ: Zakładać maskę przeciwpyłową Käytä pölysuojust : Bär mask mot damm : Der skal benyttes beskyttelsesmaske mod støv: Purtati mască anti-praf :</p>	<p>Наденьте респиратор : Toza karşı maske takın : Používejte masku proti prachu : Noste ochrannú masku proti prachu : Bruk en støvmaske: ليس قناع مضارض للغباب. Viseljen porvédő maszkot Nositi zaščitno masko proti prahu: Да се използва защитна маска : Kandke tolmumaski. Dėvėti respiratorių Valkāt aizsarg masku pret putekļiem Nositi masku za zaštitu od prašine:</p>	×
---	---	---	---

	<p>Porter une protection auditive : Wear hearing protective equipment: Gehörschutz tragen: Llevar puesta una protección auditiva: Portare una protezione uditiva: Utilizar uma protecção auditiva: Draag gehoorbeschermers: ΦΟΡΑΤΕ ΠΡΟΣΤΑΣΙΑ ΑΚΟΗΣ: Zakładać słuchawki ochronne Käytä kuulosuojaimia: Bär hörselskydd: Der skal benyttes høreværn: Purtati căști de protecție auz:</p>	<p>наденьте средства звуковой защиты: İşitsel koruma aleti takın: Používejte ochranu sluchu: Noste ochranné slúchadlá: Bruk hørselsvern: ليس عوذة خرض الضجيج Viseljen fülvédőt Nositi zašito ušes: Да се използва слухови защитни средства: Kandke kõrvakaitset Nešioti apsaugą nuo triukšmo Valkāt dzirdes aizsarglīdzekli Nositi štītnike protiv buke:</p>	×
--	--	--	---

	<p>Porter des gants : Use rubber gloves : Scchutzhandschuhe tragen : Llevar guantes de protección : Indossare i guanti di protezione : Utilizar luvas de protecção : Draag veiligheidshandschoenen : ΦΟΡΩΝΤΑΣ ΓΑΝΤΙΑ: Używać rękawic ochronnych : Käytä suojakäsineitä : Använd skyddshandskar : Der skal benyttes handsker : Purtati mānuši :</p>	<p>Наденьте перчатки : Eldiven takın : Noste rukavice : Noste rukavice : Bruk hansker: ليس قفازات. Viseljen kesztyű t Nositi rokavice: а се използват предпазни ръкавици : Kandke kindaid Mūvēti pirštines Valkāt cimds Nositi zaštitne rukavice:</p>	×
---	--	---	---





	<p>Lire les instructions avant usage : Read the instructions before use : Vor Einsatz des Geräts Anweisung lesen : Léase las instrucciones antes de usar : Leggere le istruzioni prima dell'uso : Ler as instruções antes da utilização : Lees voor het gebruik de instructies : ΔΙΑΒΑΣΤΕ ΤΙΣ ΟΔΗΓΙΕΣ ΠΡΙΝ ΑΠΟ ΤΗ ΧΡΗΣΗ: Zapoznać się z instrukcją przed użyciem : Lue ohjeet ennen käyttöä : Läs anvisningarna före användning : læs instruktionerne før brug Înainte de utilizare, cititi instructiunile :</p>	<p>Внимательно прочитайте следующие инструкции : Kullanmadan talimatları okuyunuz : Pozorně si přečtěte následující pokyny : Pred použitím si prečítajte pokyny : Les bruksanvisningen før bruk: اقرأ التعليمات قبل الاستخدام. használat előtt olvassuk el az utasítást : Pred uporabo preberite ustrezna navodila Прочетете указанията за употреба : Enne kasutamist lugege instruksiooni Prieš naudojimą perskaityti instrukciją izlasīt instrukcijas pirms lietošanas Pročitati upute prije uporabe:</p>	X

	<p>Conformité européenne Conforms to EC standards : CE-Konformität : Cumples con las directivas CE : Conforme alle norme CE : Conforme às normas CE : Voldoet aan de EG-normen : ΕΥΡΩΠΑΪΚΗ ΣΥΜΜΟΡΦΩΣΗ Zgodność z normami CE : EU-standardien mukainen : EU-standardien mukainen : Overholder EU standarderne : Conform cu normele europene:</p>	<p>соответствие европейским стандартам: Avrupa uygunluk : evropská shoda : európska dohoda : Europeisk konformitet مطابق للجواصفات الأوروبية. evropska ustreznost : európai megfelelőség : Съответствие с европейските норми : Euroopa Liidu vastavusmärk Europinių normų atitikima Atbilstība Eiropas standartiem Europska skladnost</p>	X

	<p>Danger : Danger : Gefahr : Peligro : Pericolo : Perigo : Gevaar : ΚΙΝΔΥΝΟΣ: Niebezpieczeństwo : Vaara : Fara : Fare : Pericol :</p>	<p>Опасно : Tehlike : Nebezpečí : Nebezpečenstvo : Fare: خطر. Veszély : Nevarnost: Опасност : Oht Pavojus Bistamība Opasnost:</p>	X

	<p>Poids : Weight : Gewicht : Peso : Peso : Peso : Gewicht : ΒΑΡΟΣ : Masa : Paino : Vikt : Vægt : Greutate :</p>	<p>Без : Ağrılık : Hmotnost : Hmotnosť : Vekt: الوزن. Súly : Teža : Тегло : Raskus Svoris Svars Težina</p>	1,1 kg





	<p>Soumis à recyclage Subjected to recycling Sujeto a reciclaje Sottoposti a riciclaggio Sujeitos à reciclagem Não deite no lixo : Niet wegwerpen : ΥΠΟΚΕΙΤΑΙ ΣΕ ΑΝΑΚΥΚΛΩΣΗ Nie wyrzucac : Älä heitä pois luontoon : Batteriet får inte kastas : Bortkast det ikke: Nu le auncati :</p>	<p>Подлежит переработке Atmayıniz : Nevyhazujte je do běžného odpadu : Neodhadzovat : Gjenvinningspliktig فلا ترمدها لهذا في القمامة. ne mečíte1 Ne odvržite ga/jih vstran : Taaskasutusse kuuluv Ärge visake seda minema : Nemétykíte : Nemest : Podvrgnuto recikliranju</p>	×
---	---	---	---

Recyclage des déchets :

Les outils, accessoires et leur emballages doivent suivre une voie de recyclage adaptée. Conformément aux directives Européenne 2012/19/UE et 2006/66/CE, les composants d'un produit doivent être séparés, collectés, recyclés ou éliminés en conformité avec les réglementations environnementales en vigueur. Les appareils, batteries, piles, huiles, emballages devront être déposés dans les systèmes d'élimination des déchets spéciaux tels que déchetteries. Renseignez-vous auprès de votre commune pour connaître l'organisme le plus proche à même de retraiter ou de collecter ces déchets.

	<p>Recyclable, soumis au tri sélectif Recyclable, subject to recycling Recyclingfähige, unterliegen Recycling Reciclables, sujetos a reciclaje Riciclabili, soggetti a riciclaggio Recicláveis, sujeito à reciclagem Recycleerbare, onderworpen aan recycling ΑΝΑΚΥΚΛΩΣΙΜΟ, ΥΠΟΚΕΙΤΑΙ ΣΕ ΕΠΙΛΕΚΤΙΚΗ ΔΙΑΛΟΓΗ Opakowanie nadaje się do recyklingu podlegają recyklingu Kierrätettävien pakkausten kohteena kierrätys Återvinningsbara förpackningar omfattas återvinning Рециклираци се опаковки подлежат на рециклиране Genarvendelig underlagt genbrug</p>	<p>Reciclabile sub rezerva reciclare Повторно упаковка подлежит вторичной переработке Geri dönüştürüm Geri dönüştürülebilir ambalaj konusu Recyklovateľné podléhajúci recyklácii Recyklovateľné podliehajúce recyklácii Resirkulerbar, med förbehold om selektiv sortering ريوندلدا هذا عال يغرضت ريوندلدا هذا عال قلبنا ازلنا فجلنا و قوب بندا Újrahasznosítható csomagolás alá újrahasznosítás Reciklirati predmet recikliranje Pakendite suhtes ringlussevõtu Pārstrādājams iepakojums otrreizējai pārstrādei Perdirbamų taikomos perdirbimo Može se reciklirati, podložno selektivnom sortiranju</p>	×
---	--	--	---



AG 50

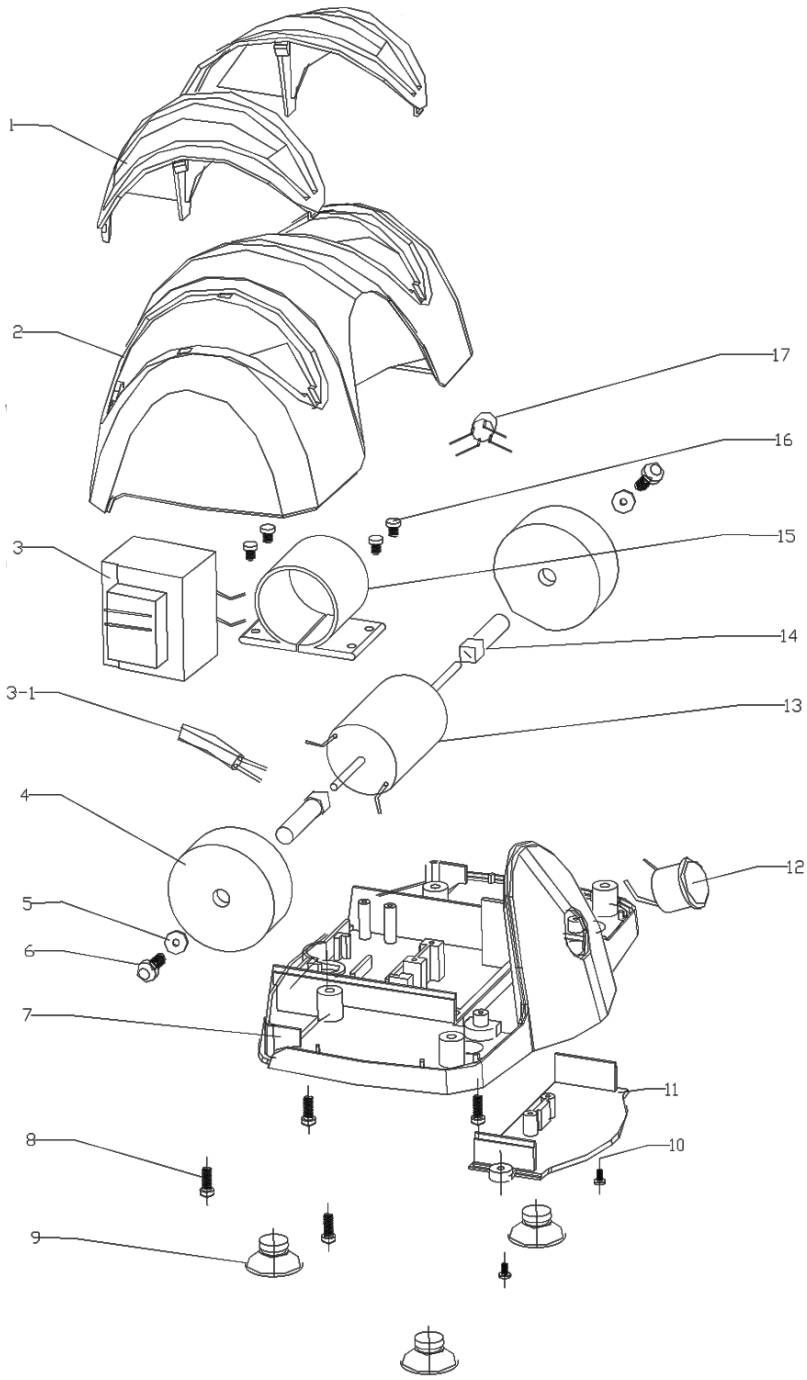

DECLARATION DE CONFORMITE
VERKLARING VAN OVEREENSTEMMING
DECLARACION DE CONFORMIDAD
DICHIARAZIONE DI CONFORMITA
KONFORMITÄSERKLÄRUNG
DECLARATION CONFORMITY
DECLARAÇÃO DE CONFORMIDADE
DEKLARACJA ZGODNOSCI Z NORMAMI
OM ÖVERENSSTÄMMELSE
VAATIMUSTENMUKAISUUSVAKUUTUS
ÖVERENSSTEMMELSESERKLÄRING
ΔΗΛΩΣΗ ΣΥΜΜΟΡΦΩΣΗΣ

DECLARAȚIE DE CONFORMITATE
VYHLÁSENIE ZHODY
Декларация соответствия
SAMSVARERKLÆRING
Uygunluk beyanı
الاصدريج بالمطابق ة
PROHLÁŠENÍ SHODY
EGYZŐSÉGI NYILATKOZAT
Декларация за съответствие с нормите
IZJAVA O SKLADNOSTI
DEKLARACIJA
ATTIKITIES DEKLARACIJA
KINNITUS
IZJAVA O SUKLADNOSTI

Le soussigné,
Ondergetekende,
Der Unterzeichner,
O abaixo assinado,
Undertecknad,
Долуподписаният
Undertegnede
Subsemnatul,
Я, нижеподписавшийся,
Imzalayan,
Niže podepsany,
Toliau pasirašęs

Déclare par la présente que,
Verklaart hiermede dat,
Erklärt hiermit daß,
Declara pela presente que,
Förklarar härmed att
Заявява с настоящото
erklærer hermed, at
Declar prin prezenta că,
настоящим подтверждаю, что
Mevcut belgeyle beyan ediliyor ki,
tımto prohlasuje, že,
Pareiskia, kad,

Personne autorisée à constituer
le dossier technique :
Christophe HUREL



FAR GROUP EUROPE
192, Avenue Yves Farge
37700 St. Pierre-des-Corps
FRANCE

El suscrito,
Il sottoscritto,
The undersigned,
Ninej podpisany
Allékirjoittanut,
Ο ΚΑΤΩΘΙ ΥΠΟΓΡΑΜΜΕΝΟΣ,
Nižšie podpisany
Undertegnede,
الاصدريج بالاصدريج
Alulírott,
Podpisani,
Apakša parakstijies
allakirjutanu
Dolje potpisani,

Declara por la presente, que,
Dichiare che,
Declares that,
Oowiadzca niniejszym, że
Ilmoitetaan täten että,
ΔΙΑ ΤΟΥ ΠΑΡΟΝΤΟΣ ΔΗΛΩΝΕΙ ΟΤΙ,
tımto vyhlasuje, že
Erklærer herved at,
يصرح استنادا على ذلك
kijelentem, hogy a készülek Izjavlja da,
Pareiskia, kad,
Ar šo apliecinā, ka,
Kinnitab, et
Izjavljuje u ovom dokumentu da je

Aiguseur universel / Universal sharpener / Universalschleifer / Afilador universal / Affilatore universale / Afilador universal /
Universeel slijptoeisel / Μηχανή ακονίσματος γενικής χρήσης / Ostrzałka uniwersalna / Veitsenteroitin (yleismalli) / Universalvässar / Universalvässare /
Универсален шмиргел / Universal knivskærper / Polizor universal / Универсальная заточка / Universal bileyci /
Univerzální brusič / Univerzálny brusič / תשימוש ללב חותמת / خراواتی ایاع ذشم / Univerzální česťo / Univerzální brusilník /
Universalus galąstojas / Universālais asinātājs / Univerzalno oštrenje

code

FARTOOLS / 110162 / AG 50 / MDQ 3002

Est conforme et satisfait aux directives et normes CE,
In overeenstemming is met en voldoet aan EG richtlijnen,
Den følgende EU-Bestimmungen entspricht,
Respeita e está em conformidade com as normas CE,
Överensstämmer med och uppfyller EG-standarder,
Съответства и отговаря европейските норми
Er i overensstemmelse med og overholder EU standarderne
Este conform și satisfacă normele CE
полностью соответствует и удовлетворяет
требованиям стандартов ЕС
CE şartlara uygundur,
odpovídá normám ES.
Atitinka ir atitinka EB direktyvas ir standartus,

Cumple con la directivas de la CE,
E conforme alle direttive CEE,
Complies with the EEC directives and standards,
Odpowiada normom UE,
Täyttää EU-vaatimukset,
ΣΥΜΜΟΡΦΩΝΕΤΑΙ ΚΑΙ ΙΚΑΝΟΠΟΙΕΙ ΤΙΣ ΟΔΗΓΙΕΣ ΚΑΙ ΤΑ ΠΡΟΤΥΠΑ CE,
zodpovedá normám ES.
Samsvarer med og tilfredsstiller CE-direktiver og standarder,
Ban al-jawaz yطابق و يلى م عاى يور م جو عة الدول الاوروبية
kielegiti a CE szabványok előírásait.
Je v skladu z in izpolnjuje norme Evropske skupnosti.
Atbilst un atbilst EK direktivas un standartus,
Vastab ja vastab EU direktividele ja standartitele,
Sukladan i ispunjava direktive i standarde CE,

2014/35/EU, 2014/30/EU, 2011/65/EU, 2015/863/EU

EN60335-1: 2012+A11:2014+A13:2017+A1:2019+A2:2019
EN60335-2-14:2006+A1:2008+A11:2012+A12:2016
EN IEC 55014-1:2021
EN IEC 55014-2:2021
EN IEC 61000-3-2:2019+A1:2021
EN61000-3-3:2013/A2:2021/AC:2022-01

Christophe HUREL,
Président Directeur Général
07/09/2023
Fait à St. Pierre-des-Corps



FAR TOOLS

AG 50
110162

Made in P.R.C.

230V-50Hz 20 W 3700.min⁻¹ 50 x 6 x 16 mm

CE

1,1 kg

FAR GROUP EUROPE
192, Avenue Yves Farge - 37700 St. Pierre-des-Corps - FRANCE
MDQ 3002
Serial number / numéro série :

GARANTIE - WARRANTY



FR. GARANTIE

Cet outil est garanti contractuellement contre tout vice de construction et de matière, à compter de la date de vente à l'utilisateur et sur simple présentation du ticket de caisse. La garantie consiste à remplacer les parties défectueuses. Cette garantie n'est pas applicable en cas d'exploitation non conforme aux normes de l'appareil, ni en cas de dommages causés par des interventions non autorisées ou par négligence de la part de l'acheteur. La garantie ne s'applique pas sur les dommages causés par une défaillance de l'outil.

DE. GARANTIE

Die Garantiezeit für dieses Gerät in bezug auf Konstruktions- und Materialfehler beträgt lt. Vertrag bei Vorlage des Kassensbons. Die Garantieleistung besteht im Ersatz schadhafter Teile. Die Garantie erlischt bei einem Einsatz des Geräts, der nicht normentsprechend ist, bei Schäden, die auf unsachgemäße Eingriffe zurückzuführen sind bzw. bei Nachlässigkeit seitens des Käufers. Die Garantie erstreckt sich nicht auf Schäden, die auf Fehlfunktionen des Geräts zurückzuführen sind.

IT. GARANTIA

Quest' attrezzo è garantito per contratto contro qualsiasi difetto di costruzione e di materia, a partire dalla data di vendita all'utente e su semplice presentazione dello scontrino. La garanzia consiste nel sostituire le parti difettose. Questa garanzia non è applicabile in caso di struttamento non conforme alle norme dell'apparecchio, né in caso di danni causati da interventi non autorizzati o da negligenza da parte dell'acquirente. La garanzia non si applica ai danni causati da un'avarità dell'attrezzo.

EN. GARANTIE

This tool is guaranteed, in writing, against any defect in manufacture or parts from the date of sale, upon simple presentation of the sales slip. The guarantee is limited to the replacement of faulty parts. This guarantee is not applicable in the event of usage which is not conform with the intended usage of the apparatus, nor in the event of damage caused by unauthorised servicing or negligence on behalf of the purchaser. This guarantee does not apply to any damage caused by

the failure of this tool.

ES. GARANTIA

Esta herramienta se garantiza contractualmente contra todo defecto de construcción y materia, a partir de la fecha de venta a l usuario y sobre simple presentación del recibo de caja. La garantía consiste en sustituir a las partes defectuosas. Esta garantía no es aplicable en caso de explotación no conforme a las normas del aparato, ni en caso de daños causados por intervenciones no autorizadas o por negligencia por parte del comprador. La garantía no se aplica sobre los daños causados por un fallo del herramienta.

NL. GARANTIE

Dit gereedschap heeft een garantie tegen constructiefouten en materiaaldefecten, die geldig is vanaf de aankoopdatum door de gebruiker, op vertoning van de kassabon. De garantie betreft de vervanging van de defecte onderdelen. Deze garantie is niet van toepassing indien het apparaat niet volgens de normen gebruikt is, noch in geval van schade veroorzaakt door oneigenlijk gebruik of nalatigheid van de koper. De garantie is niet van toepassing op schade voortvloeiend uit een defect van het gereedschap.

PT. GARANTIA

Esta ferramenta tem uma garantia contratual contra qualquer defeito de construção e de material, a partir da data de venda ao utilizador e sobre simples apresentação do talão da caixa. A garantia consiste em substituir as partes defeituosas. Esta garantia não é aplicável no caso de exploração não conforme as normas do aparelho, nem em caso de danos causados pelas intervenções não autorizadas ou por negligência da parte do comprador. A garantia não se aplica para os danos causados por uma falha da ferramenta.

EL. ΕΓΓΥΗΣΗ

ΑΥΤΟ ΤΟ ΕΡΓΑΛΕΙΟ ΕΙΝΑΙ ΣΥΜΒΑΤΙΚΑ ΕΓΓΥΗΜΕΝΟ ΓΙΑ ΟΠΟΙΟΔΗΠΟΤΕ ΚΑΤΑΣΚΕΥΑΣΤΙΚΟ ΚΑΙ ΥΛΙΚΟ ΕΛΑΤΤΩΜΑ, ΑΠΟ ΤΗΝ ΗΜΕΡΟΜΗΝΙΑ ΠΩΛΗΣΗΣ ΣΤΟΝ ΧΡΗΣΤΗ ΚΑΙ ΜΕ ΤΗΝ ΕΠΙΔΕΙΞΗ ΤΗΣ ΑΠΟΔΕΙΞΗΣ ΠΩΛΗΣΗΣ. Η ΕΓΓΥΗΣΗ ΣΥΝΙΣΤΑΤΑΙ ΣΤΗΝ ΑΝΤΙΚΑΤΑΣΤΑΣΗ ΤΩΝ ΕΛΑΤΤΩΜΑΤΙΚΩΝ ΕΞΑΡΤΗΜΑΤΩΝ. ΑΥΤΗ Η ΕΓΓΥΗΣΗ ΔΕΝ ΙΣΧΥΕΙ ΣΕ ΠΕΡΙΠΤΩΣΗ ΛΕΙΤΟΥΡΓΙΑΣ ΠΟΥ ΔΕΝ ΣΥΜΜΟΡΦΩΝΕΤΑΙ ΜΕ ΤΑ ΠΡΟΤΥΠΑ ΤΗΣ ΣΥΣΚΕΥΗΣ, ΟΥΤΕ ΣΕ ΠΕΡΙΠΤΩΣΗ ΖΗΜΙΑΣ ΠΟΥ ΠΡΟΚΑΛΕΙΤΑΙ ΑΠΟ ΜΗ ΕΞΟΥΣΙΟΔΟΤΗΜΕΝΕΣ ΕΠΕΜΒΑΣΕΙΣ Ή ΑΜΕΛΕΙΑ ΕΚ ΜΕΡΟΥΣ ΤΟΥ ΑΓΟΡΑΣΤΗ. Η ΕΓΓΥΗΣΗ ΔΕΝ ΙΣΧΥΕΙ ΓΙΑ ΖΗΜΙΕΣ ΠΟΥ ΠΡΟΚΑΛΟΥΝΤΑΙ ΑΠΟ ΑΣΤΟΧΙΑ ΕΡΓΑΛΕΙΟΥ.

PL. GWARANCJA

Narz dzie jest objte gwaranc-

jà na wszelkie wady konstrukcyjne i materiałowe, licząc od daty sprzedaży u użytkownika i po okazaniu paragonu kasowego. Gwarancja obejmuje wymianę cz. A. Ci wybrakowanych. Gwarancja nie znajduje zastosowania w przypadku u użytkownika niezgodnego z normami urzadzzenia, ani w przypadku szkod spowodowanych działaniami niedozwolonymi lub zaniedbaniami ze strony nabywcy. Gwarancja nie obejmuje szkod powstałych z powodu upadku urzadzzenia.

SV. GARANTI

Detta verktyg har en avtalsenlig garanti mot konstruktions och materialfel, från och med tidpunkten för användarens inköp och genom uppvisning av kassakvittot. Garantin består i att ersätta de bristfälliga delarna. Denna garanti gäller inte om användningen inte motsvarar apparatens standarder, inte heller vid skador som orsakas av ej tillåtna ingrepp eller på grund av köparens vårdslöshet. Garantin gäller inte forskador som orsakats av att verktyget fungerat bristfälligt.

FI. TAKUU

Tämän laitteen takuu on voimassa sopimuksen mukaisesti kattaen kaikki rakenne- ja materiaali- ja lukien ostopäivästä kassakuitia vastaan. Takuu sisältää viallisten osien korvaamisen. Takuu ei korvaa ohjeiden vastaista käyttöä eikä valtuuttamattomien henkilöiden käsittelyä tai ostajan huolimattomuudesta aiheutuneita vahinkoja. Takuu ei vastaa myöskään toimintahäiriöistä aiheutuneita vahinkoja.

BU. ГАРАНЦІЯ

Този инструмент е под договорна гаранция срещу всякакъв дефект в изработката и използваните материали, считано от датата на продажба на потребителя и само срещу представяне на касовата бележка. Гаранционното обслужване се състои в замяна на дефектните части. Настоящата гаранция не е валидна когато апаратът се използва по начин, несъответстващ на стандарта за работа с него, както и в случай на щети, нанесени от неотризирани лица, или вследствие на проявена небрежност от страна потребителя.

Гаранцията не покрива щети, произтекли вследствие на техническа неизправност на апарата.

DA. GARANTI

Dette værktøj er dækket af en garantikontrakt for konstruktions- og materialefejl, som gælder fra købsdatoen ved visning af kassabon. Garantien består i at udskifte de defekte dele. Garantien dækker ikke fejl opstået som følge af anvendelse, som ikke overholder standarderne for apparatet, eller

SERVICE APRÈS VENTE - AFTER SALE SERVICE

FARGROUP EUROPE - 192, Avenue Yves Farge - 37700 St. Pierre-des-Corps - FRANCE

fargroup@fargroup.net

GARANTIE - WARRANTY



skader opstået ved ikke autoriserede indgreb eller sløsethed fra brugerens side. Garantien dækker ikke skader opstået, fordi værktøjet har svigtet.

RO. GARANTIE

Acest aparat este garantat din punct de vedere contractual împotriva tuturor viciilor de construcție și de material, începând de la data vânzării lui către utilizator și la simpla prezentare a bonului de casă. Garanția constă în înlocuirea componentelor defecte. Această garanție nu se aplică în cazul exploatarii în alt mod decât cel recomandat de normele aparatului și nici în caz de stricăciuni provocate de intervenții neautorizate sau prin neglijența cumpărătorului. Garanția nu se aplică asupra pagubelor cauzate de o defectare a aparatului.

RU. ГАРАНТИЯ

Данное изделие обладает имеющей, силу контракта гарантией, покрывающей все возможные дефекты изготовления и материала. Гарантия вступает в силу с даты продажи изделия пользователю, для этого достаточно сохранить и предъявить полученный в кассе Чек. Гарантия обязывает изготовителя заменить дефектные части изделия. В случае не соответствующего нормам использования изделия, несанкционированного демонтажа или ремонта или небрежного обращения действие гарантии прекращается. Гарантия не покрывает ущерба, возникшего в результате сбоев в работе изделия.

TU. GARANTI

Bu arac, satis tarihinden itibaren, kullanıcının sâdece vezne alindisini sunmasiyla tum uretim ve malzeme hatasina karsi garantilidir. Garanti eksik olan kisimlari degistirmek icindir. Bu garanti aracin sartlarina uygun olmayan isleme durumunda, izin verilmeden kullanimlardan kaynaklanan hasarlarda veya alicinin istegi durumunda uygulanmaz. Garanti malzemenin bir eksikliginden meydana gelen bir zararda uygulanmaz.

CS. ZÁRUKA

Pro tento nástroj platí smluvní záruka na všechny výrobny a materiálové vady od data prodeje uživateli a na základě predloženi pokladniho bloku. Záruka spociva ve výmene vadných castí. Táto záruka neplatí v prípade pouzitia prístroja, ktoré neodpoveda normam, ani v prípade

škod způsobených nepovolenými zásahy nebo nedbalostí ze strany kupujícího. Záruka se nevztahuje na škody způsobene zavadou nástroje.

SK. ZÁRUKA

Pre tento nástroj platí zmluvná záruka na všetky výrobne a materiálové chyby od dátumu predaja uživatelovi a na základe predloženia pokladnicneho bloku. Záruka spociva vo výmene chybnych casti. Táto záruka neplatí v prípade pouzitia prístroja, ktore nezodpoveda normam, ani v prípade škod spôsobených nepovolenými zásahmi alebo nedbalostou zo strany kupujúceho. Záruka sa nevztahuje na škody spôsobene poruchou nástroja

AR. الضمان

على مجرد تقديم بطاقة الشراء يتدخل عن تاريخ البيوع الى المستهلك وبيناً عيب فني التصني عوفى الجوانب، اعتباراً ان هذه الة مضمونة شعاقدياً عن أي اجهاز، ول في حالة تعرضه لآثار حالة الاستخدام غير المطابق لمعايير لا يلبون هذا الضمان قابلاً للتطبيق في ظل الضمان فني سبببدال الأجزاء الاعطالة لا يطبق الضمان على الضرر الناتج عن مخرضة اوفسي حالة الة هلال من قبل المشتري ناتجة عن عمليات تدخل غير

HU. GARANCIA

Erre a szerszámra szerződéses garanciát vállalunk bármilyen gyártási és anyaghiba felmerülése esetére, a fogvaszító részére történt eladás napjától számítva, a pénztári blokk egyszere felmutatása ellenében. A garancia a hibás alkatrészek cseréjére terjed ki. Ez a garancia nem érvényes, ha a készüléket nem rendeltetésszerűen használták, sem illetéktelen beavatkozások, vagy a vásárló hanyagsága okozta károk esetén. A garancia nem fedezi azokat a károkat, melyeket a szerszám hibás működése okozott.

SI. GARANCIJA

To orodje je z garancijsko pogodbo zaščiteno proti vsem napakam v izdelavi in v sestavnem materialu od datuma prodaje naprej in ta velja ob predložitvi blagajniškega računa. Garancija velja za zamenjavo delov z napako. Ta garancija ne velja za uporabo orodja, ki ni v skladu z normami, predpisanimi za omenjeno orodje in za primere okvar, ki nastanejo zaradi nedovoljenih posegov na orodju ali zaradi malomarnega rokovanja kupca. Garancija ne velja za škodo, ki jo lahko povzroci okvara orodja.

ET. GARANTII

See tööriist kuulub lepingu järgi garantiiremonti arvestades alates muumise päevast ja kassatseki alusel kasutajale koigi konstruktsioonilise materjalivigade puhul. Garantii seisneb defektsete osade välja vahetamises. See garantii ei kehti

aparaadi normide ebatavalise eiramise puhul ega ostja poolt keelatud viisil, kasutamisesest või hooletussejätmisest tulenevate kahjude korral. Garantii ei kehti seadme defektidest põhjustatud kahjude puhul

LV. GARANTĪJA

Sis prietaisais yra uztikrinamas kaip itin geros kokybes, nuo jo pardavimo datos iki jo panaudojimo, ir jam yra suteikiamas garantinis talonas. Garantijos metu galima pakeisti atsiradusius trumpliaiausius gedimus. Si garantija netaikoma esant netinkamam naudojimui ar nesilaikant reikiam šio aparato vartojimo instrukciju, tai pat paciam virkeji ji sugadinus. Garantija taip pat netaikoma, prietaisą naudojant ne pagal paskirtį ir ji apgadinus

LT. GARANTIJA

Sim darbarikam ir liguma noteikta garantija visiem defektiem, kas saistās ar konstrukciju un materiālu, sakot ar pardošanas datumu, kad mašīnu pardot lietotājam un vienkārši uzradot kases ceku. Garantija iekļauj bojāto daļu nomaiņu. Si garantija nav derīga, ja aparāts nav lietots saskaņā ar drošības noteikumiem, ne gadijums ja bojājumi radusies nesankcionētās ietauksanas gadijuma vai arī pircēja nolaidības dēļ. Garantija nav derīga, ja bojājumi radusies darbarika defekta dēļ

HR. JAMSTVO

Ovaj alat ima ugovorno jamstvo u slučaju bilo kakvih nedostataka u konstrukciji i materijalu, od datuma prodaje korisniku uz jednostavno predocenje racuna. Jamstvo se sastoji u zamjeni neispravnih dijelova. Ovo se jamstvo ne primjenjuje u slučaju uporabe i eksploatacije koja nije sukladna standardima uređaja, niti u slučaju štete uzrokovane neovlaštenim intervencijama ili nemarom kupca. Jamstvo se ne primjenjuje na štetu uzrokovanu nekim nedostatkom alata.

SERVICE APRÈS VENTE - AFTER SALE SERVICE

FARGROUP EUROPE - 192, Avenue Yves Farge - 37700 St. Pierre-des-Corps - FRANCE
fargroup@fargroup.net





FAR GROUP EUROPE

Une société du groupe **SIGMA**

192, Avenue Yves Farge
37700 St. Pierre-des-Corps
FRANCE

fartools.com

